



	max 90mm	EHN + KDN EHV + KDV
			max 45mm	EZN + KDN EZV + KDV EZJ + KDJ
			max 5mm	ESN + KDN ESV + KDV ESJ + KDJ
			12-16mm	EGV + KDV
			max 5mm (V, J) max 15mm (N)	ELN + KDN ELV + KDV ELJ + KDJ



**B1/2**

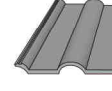
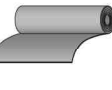
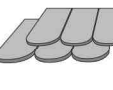
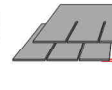
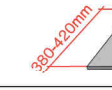
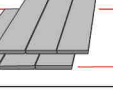
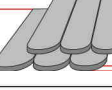

**CZ** Výrobce a Prodávce nenesú žádnou odpovědnost za nedodržení příslušných předpisů zákona, stavebních předpisů a bezpečnostních požadavků přes užívatele výrobku, architektu, montážní nebo majitele objektu.

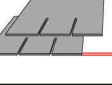
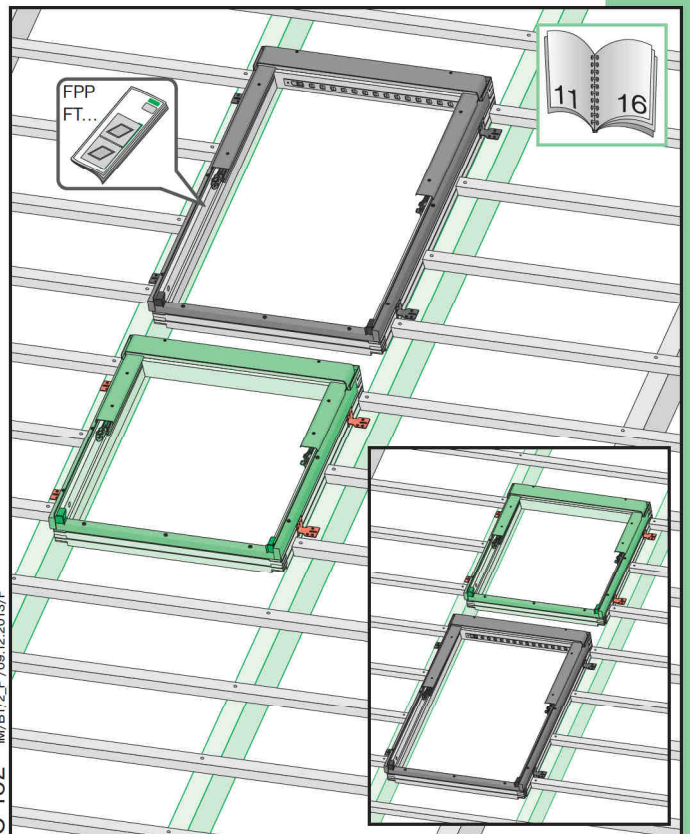
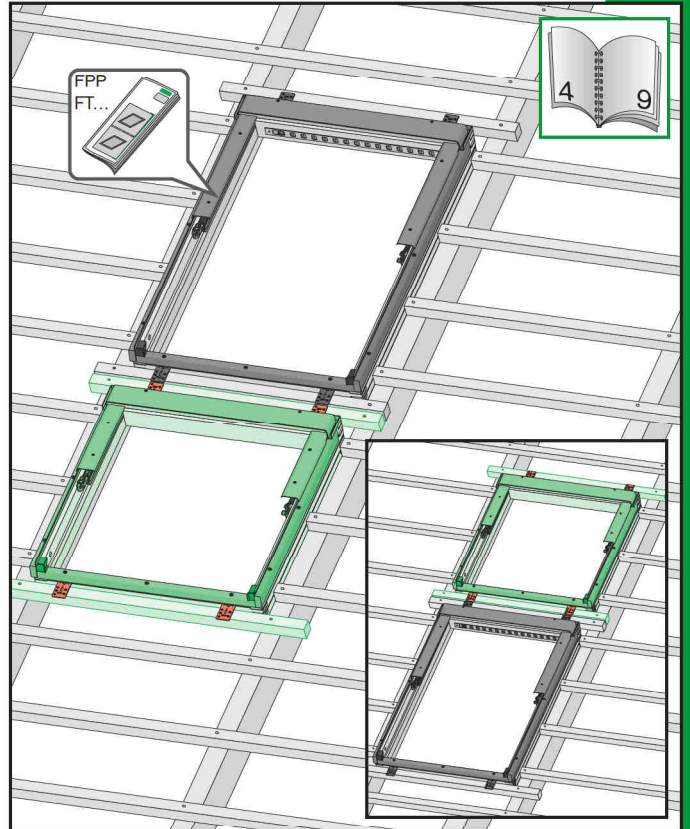
**DE** Hersteller und Verkäufer übernehmen keine Haftung für Nichtbeachtung entsprechender Rechts- und Bauvorschriften sowie Sicherheitsanforderungen seitens Produktbenutzers, Architekten, Monteurs oder Gebäudebesitzers.

**ES** El fabricante y el vendedor no tienen ninguna responsabilidad por el incumplimiento de la ley vigente, normas de construcción y exigencias de seguridad por parte del usuario del producto, arquitecto, instalador o el propietario del edificio.

**FR** Le fabricant et le vendeur ne portent aucune responsabilité de ne pas respecter les lois applicables, les règlements sur les bâtiments et les exigences de sécurité par l'utilisateur du produit, l'architecte, l'installateur ou le propriétaire du bâtiment.

**GB** Manufacturer and Seller shall bear no liability for failure to comply with the applicable laws, building codes and safety requirements by the user of the product, architect, fitter or owner of the building.

**HU** A Gyártó és a Forgalmazó nem vállal semmiféle felelősséget a vonatkozó törvényi, építési és biztonsági előírások neméért/használói, építész, beszállíktól vagy végfelhasználóktól be nem tartásáért.

**IT** Il Produttore e il Rivenditore non potranno essere ritenuti responsabili per il mancato rispetto, da parte dell'utente del prodotto, del progettista, dell'installatore o del proprietario dell'edificio, delle leggi vigenti, nonché dei regolamenti edilizi e di quelli relativi alla sicurezza.

**NL** De fabrikant en verkoper zijn niet aansprakelijk voor gevolgen bij het niet opvolgen van toepasselijke wetten, bouwbesluiten en veiligheidsvoorschriften door de gebruiker van het product, de architect, de installateur of de eigenaar van het gebouw.

**PL** Producent i Sprzedawca nie ponosi żadnej odpowiedzialności za niezapewnienie stosownych przepisów prawa, przepisów budowlanych i wymogów bezpieczeństwa przez użytkownika produktu, architekta, montażystę lub właściciela budynku.

**PT** O fabricante e o vendedor não tem nenhuma responsabilidade pelo o não cumprimento da lei, códigos de construção e as exigências de segurança por parte do usuário do produto, arquiteta, instalador ou proprietário do edifício.

**RO** Nicu producătorul, nici distribuitorul nu își vor asuma niciun fel de răspundere pentru nerespectarea legilor în vigoare, a legilor din domeniul construcțiilor sau a măsurilor de siguranță impuse utilizatorilor produsului, arhitecților, montajorilor sau proprietarilor clădirii.

**RU** В случае несоблюдения архитектором, монтажником или владельцем здания строительных правил и норм безопасности ответственность с производителя и продавца снимается.

**SK** Výrobca a predávca nenesú žiadnu zodpovednosť za nedodržanie príslušných ustanovení zákona, stavebných predpisov a bezpečnostných požiadaviek užívateľom výrobku, architektom, montážnym alebo majiteľom objektu.

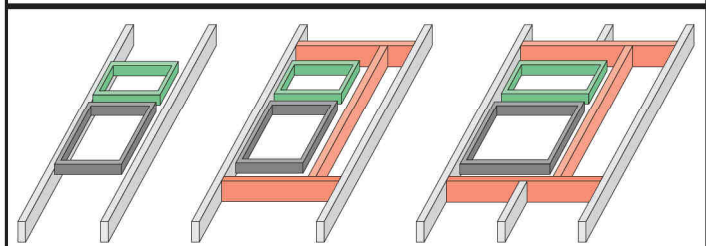
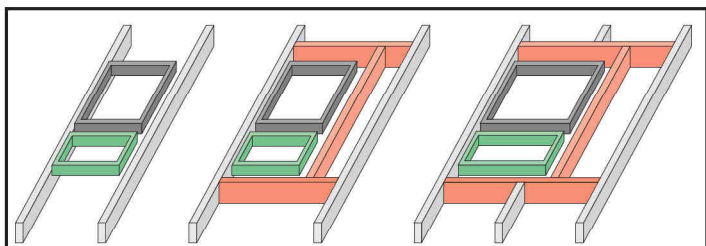
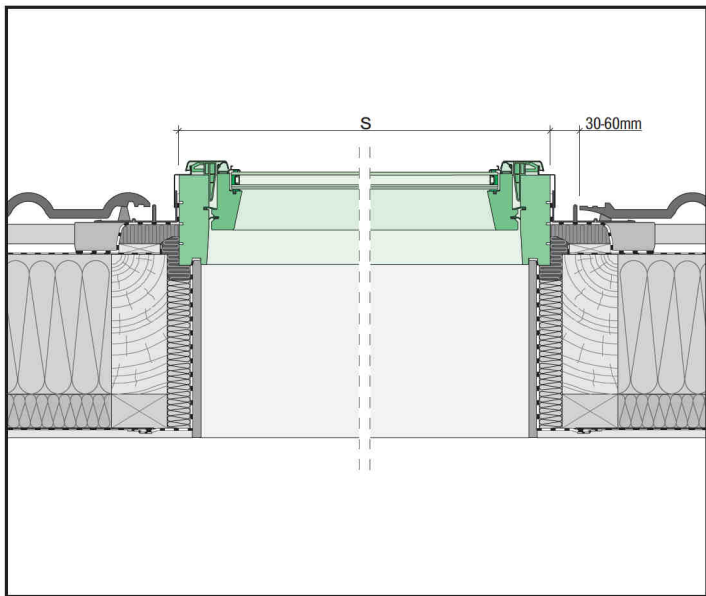
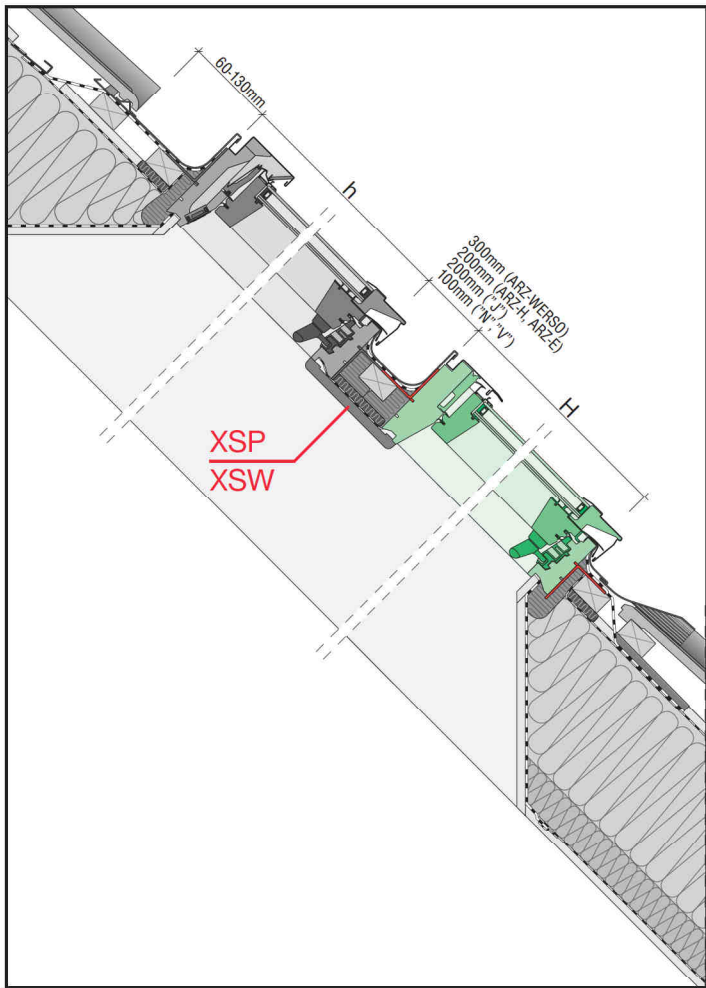

2

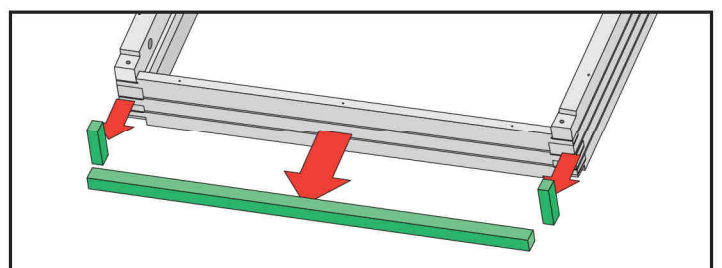
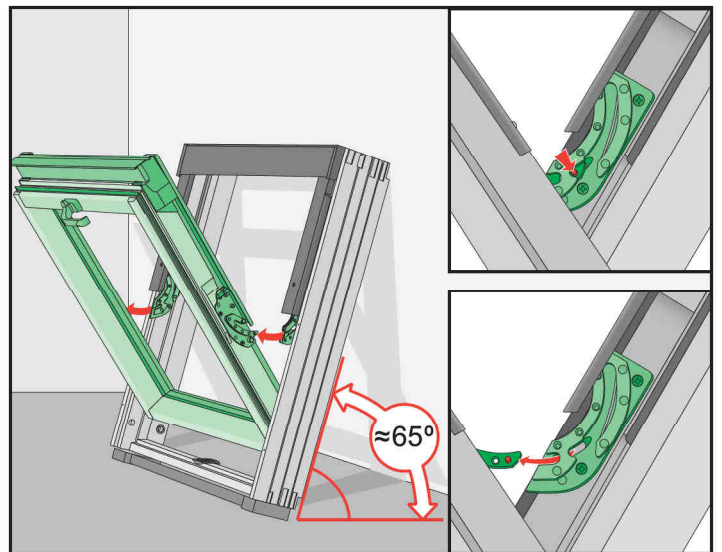
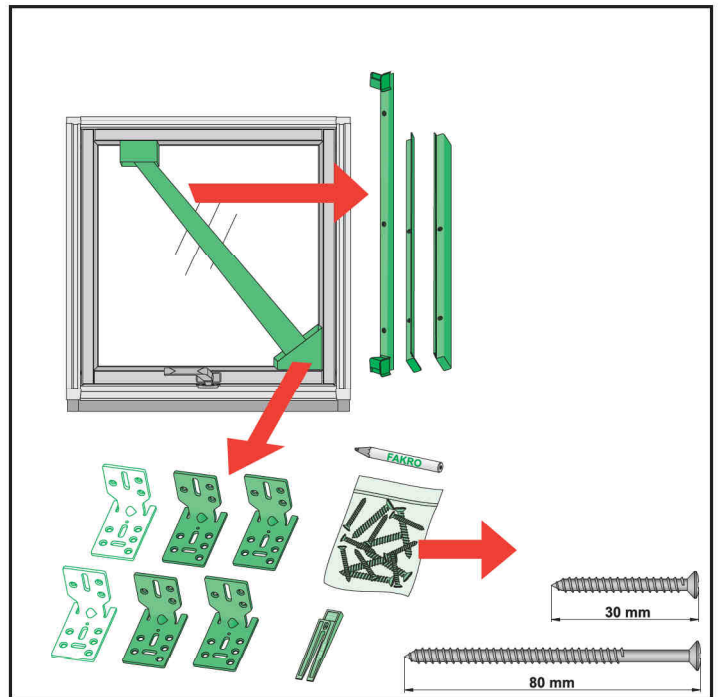
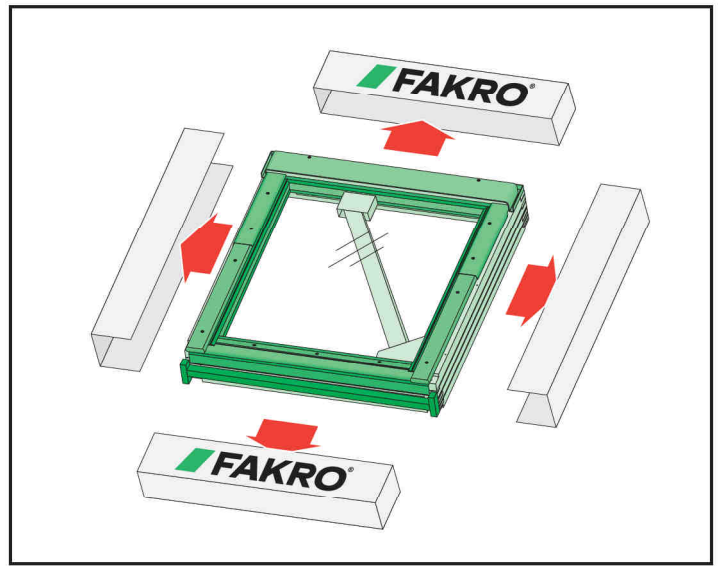

3

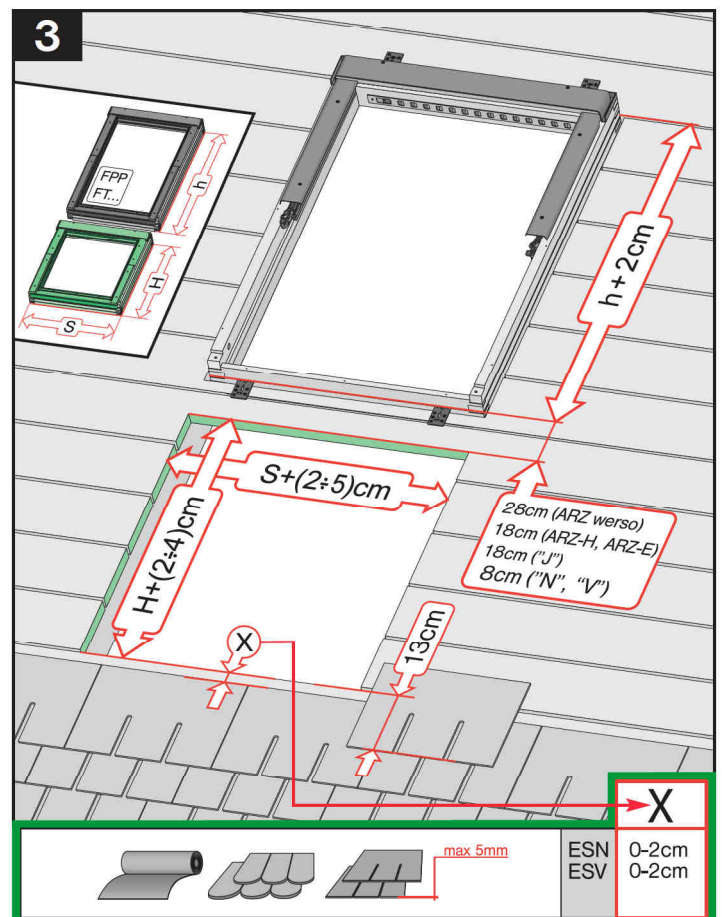
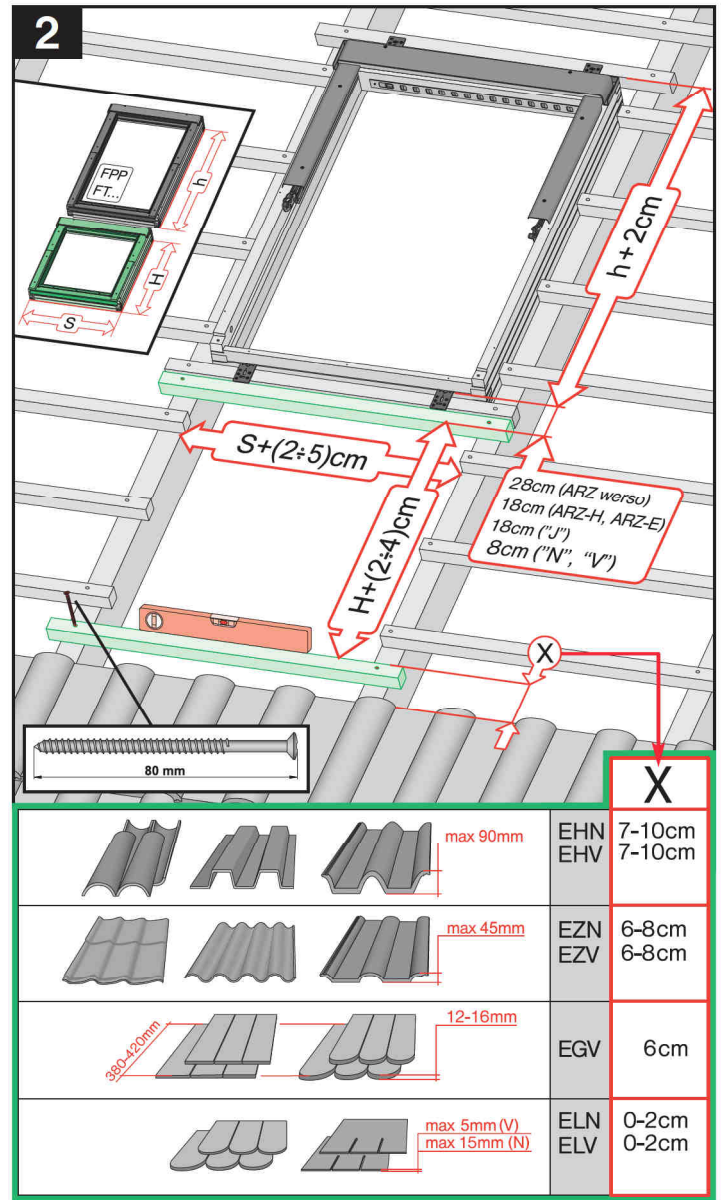
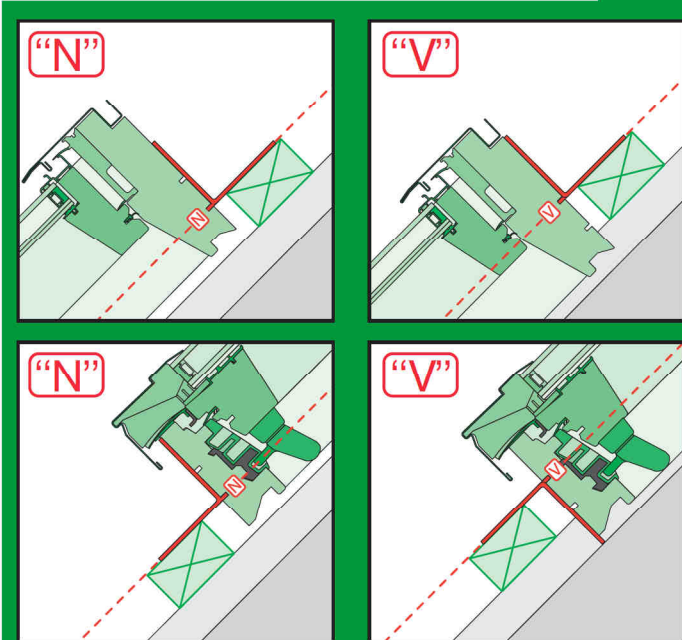
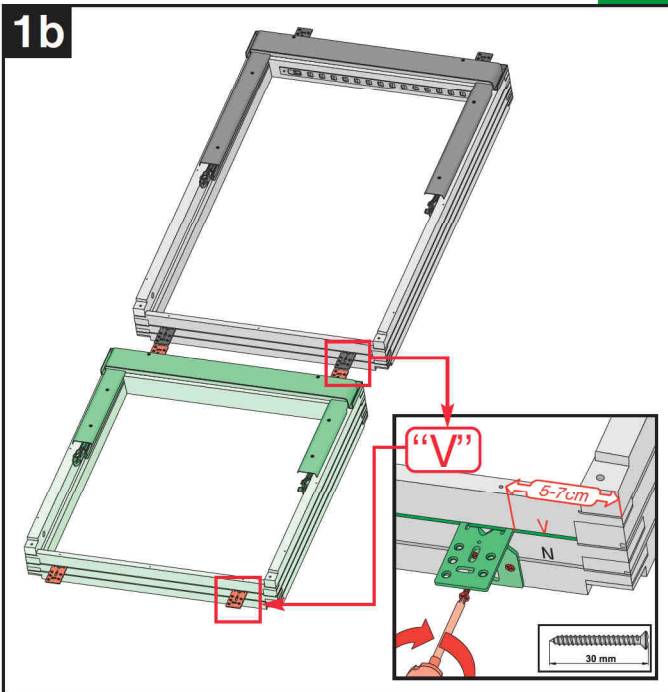
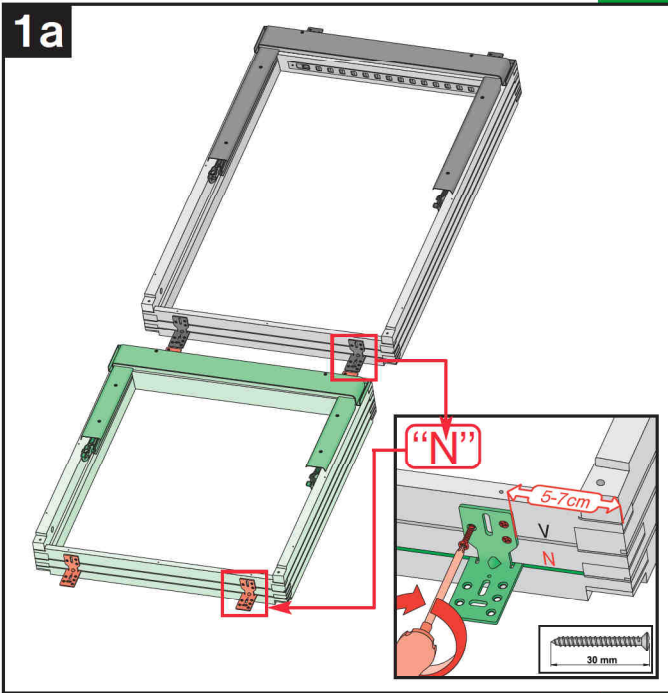

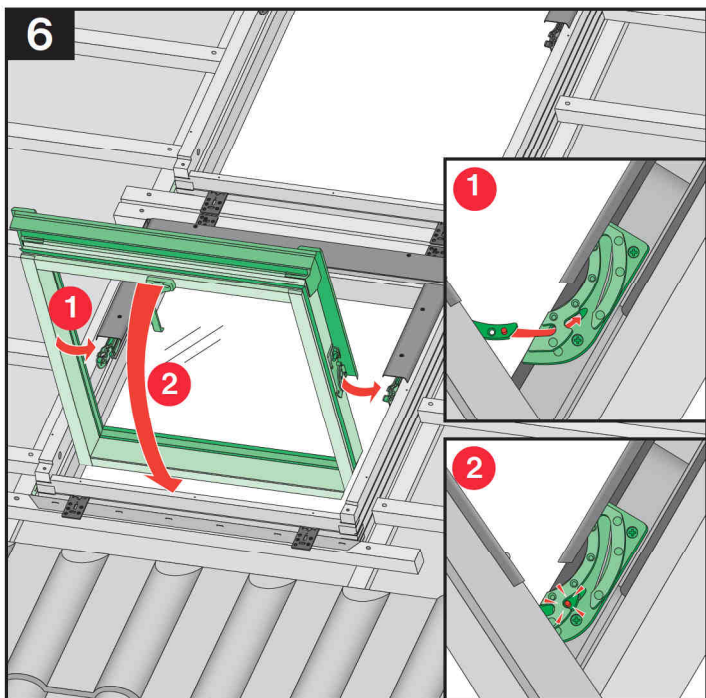
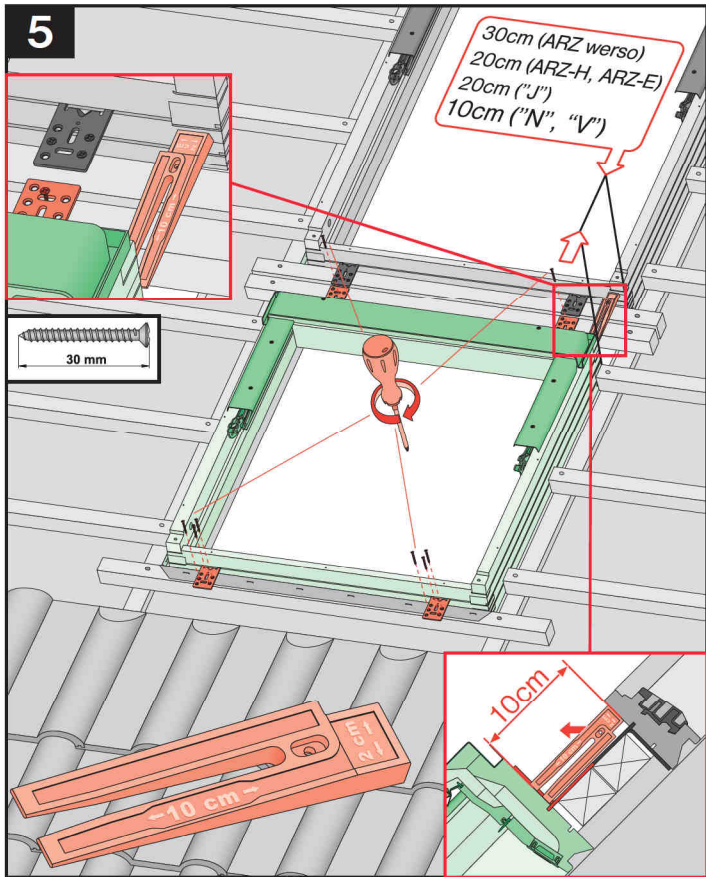
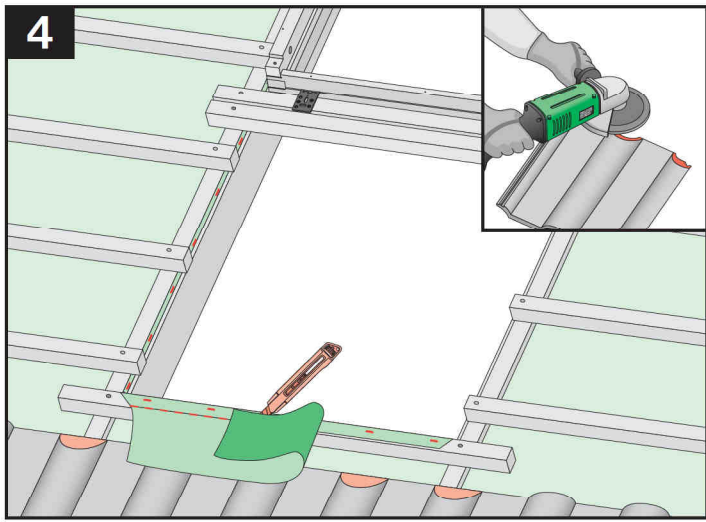

6

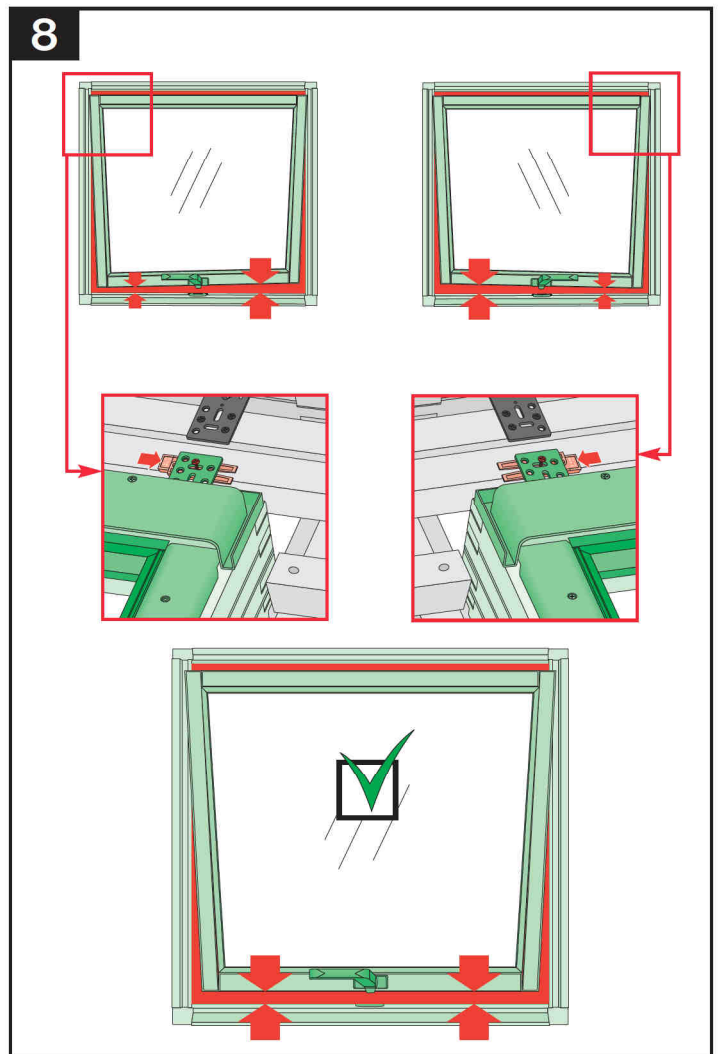
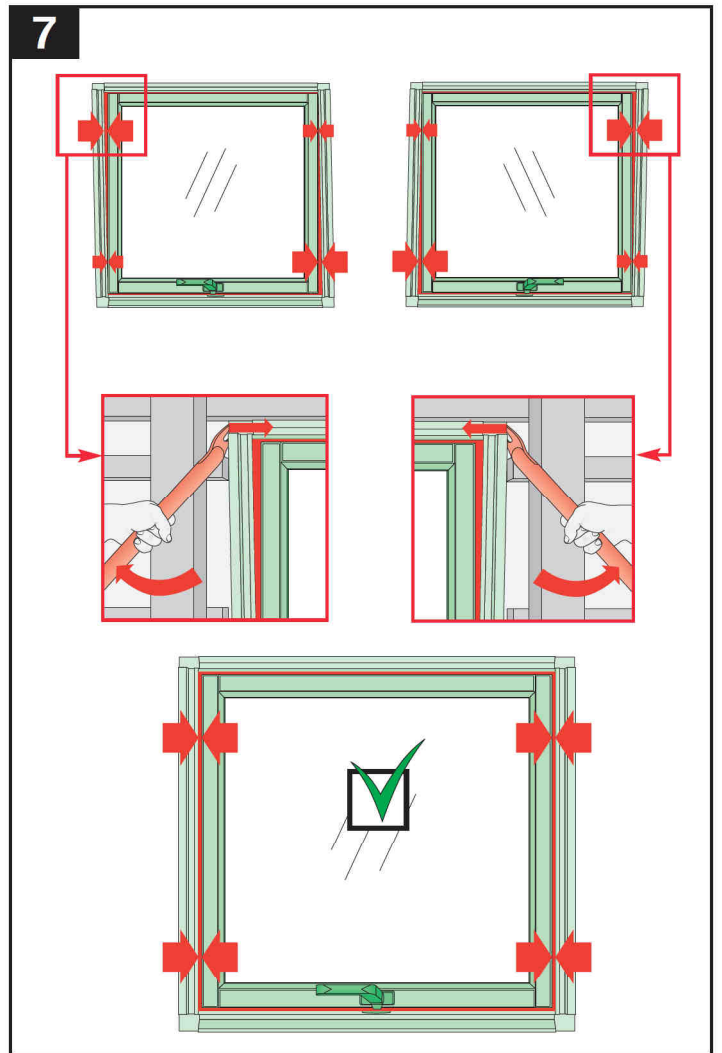

7

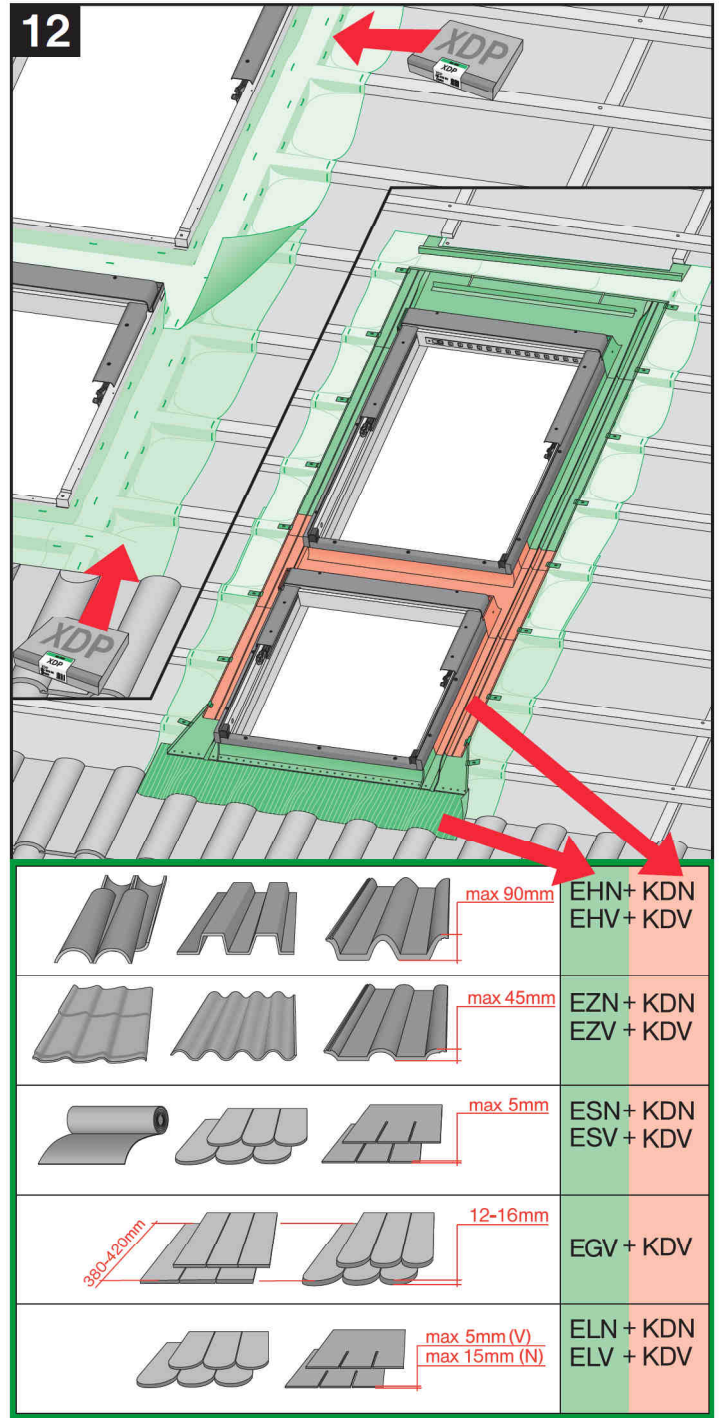
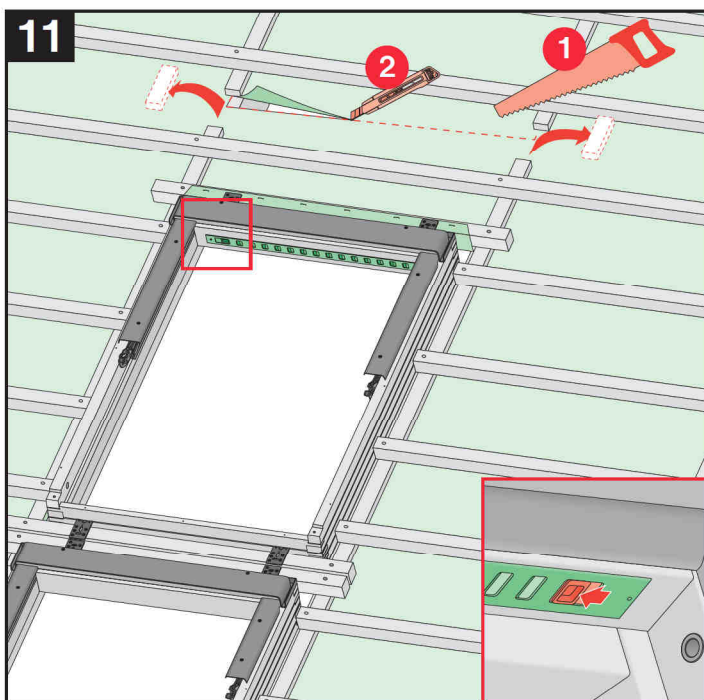
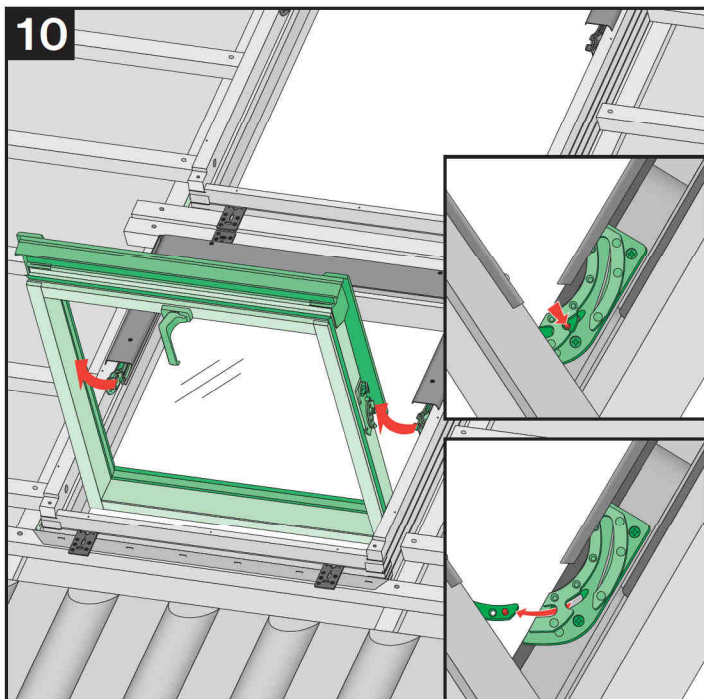
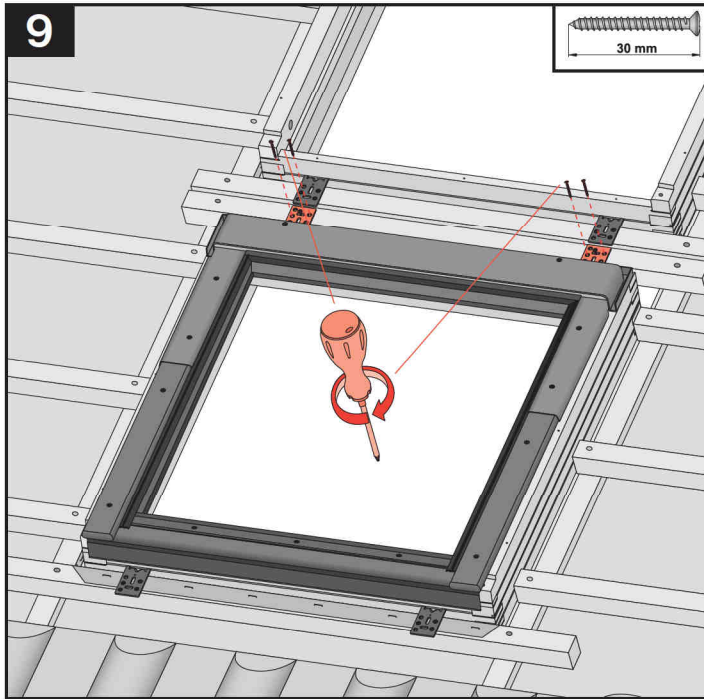

↑  
15°-90°

